

SETUP MONTAJE

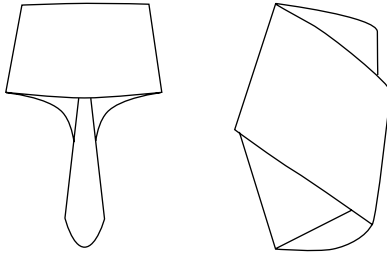

LZF

AIR & ORBIT

AIR A, ORBIT A

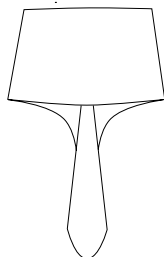

AIR A

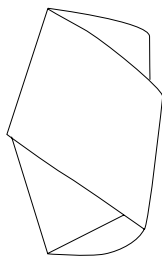

ORBITA

- 1 x Shade Pantalla
- 2 x Screws & wall plugs Tornillos y tacos
- 1 x Allen key No. 2,5 Llave Allen N° 2.5 (AIR A)
- 1 x Allen key No 3 Llave Allen N° 3 (ORBIT A)

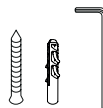

* Additional Contents UL (Only for Junction Box)

- 1 x Adjustable Back Plate
- 2 x Screws & Spherical nuts
- 1 x Allen key N° 2,5



TECHNICAL SPECIFICATIONS ESPECIFICACIONES TÉCNICAS

Recommended bulb Bombilla recomendada

Class I Clase I



AIR A



E14

LED Mini Globe DIM 1 x 5 W max.
LED regulable

220-240V 50-60Hz

ORBITA



E27

LED Mini Globe DIM 1 x 11 W max.
LED regulable

220-240V 50-60Hz

AIR A



E12

LED Mini Globe DIM 1 x 5 W max.
LED regulable

120-277V 50-60Hz

ORBITA



E26

LED Mini Globe DIM 1 x 15 W max.
LED regulable

120-277V 50-60Hz

IMPORTANT: Turn off the power before installing your lamp.

IMPORTANTE: Desconectar la red eléctrica antes de instalar la luminaria.

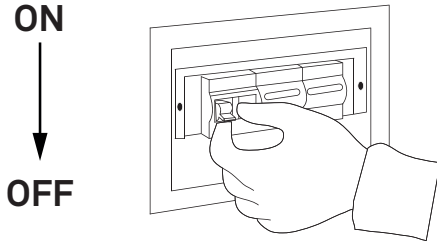

For US & Canada: skip steps 4 -5.

For Europe: skip steps 2 - 3

Para EEUU & Canadá: sátese los pasos de 4 a 5.

Para Europa: sátese los pasos de 2 a 3.

1 OPEN ABRIR

Remove these screws to separate the shade from the structure.

Quite los tornillos para separar la pantalla de la estructura.

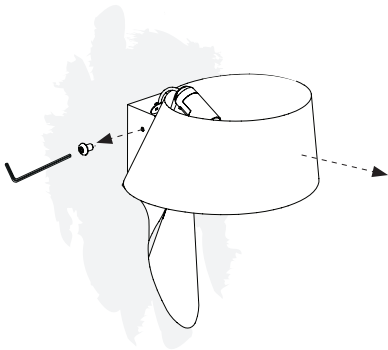

Use allen key N° 2,5
Usar llave allen N° 2,5

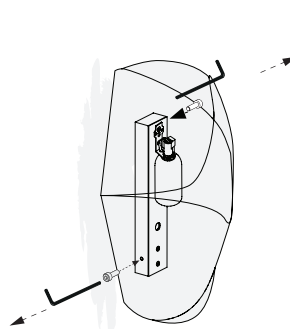

Use allen key N° 3
Usar llave allen N° 3

2 FIX TO THE WALL

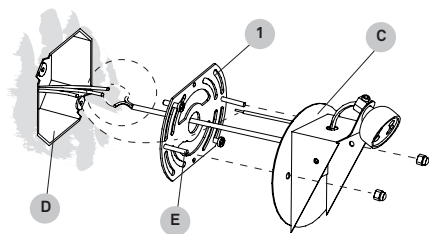

Feed the electrical wires (B) coming from the canopy through the backplate (C) and the adjustable backplate (1). Connect the electrical wires (B) to the mains inside the Jbox (D), following the diagrams below. Fix back plate (C) to the junction box (D) with the screws (E).

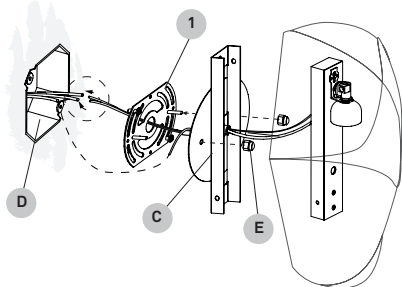

3 CONNECTION

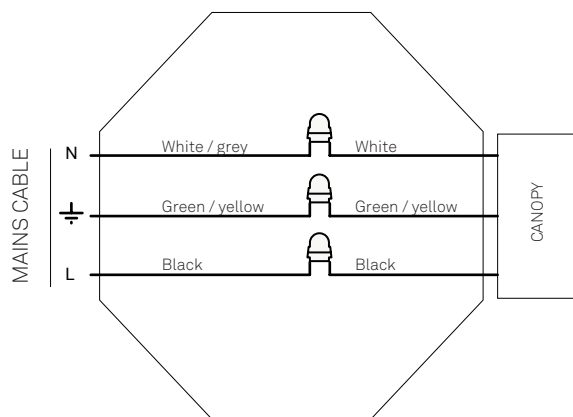

Connect the lamp to the mains as follows. You should have a three wire cable coming from the mains, N, L and GND. Connect these to the cables of the same colour coming from the lamp using connectors.

4 FIX TO THE WALL FIJAR A LA PARED

Wall mount. Feed the electrical wires (A) through the structure (B), screw the structure to the wall and connect the electrical wires to the main.

Montaje a pared. Pase los cables (A) a través de la estructura (B), atornille la estructura a la pared y conecte a la red eléctrica.

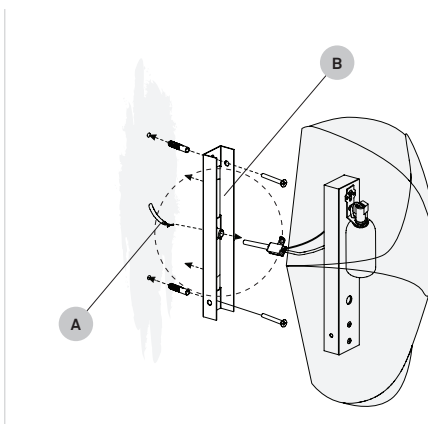
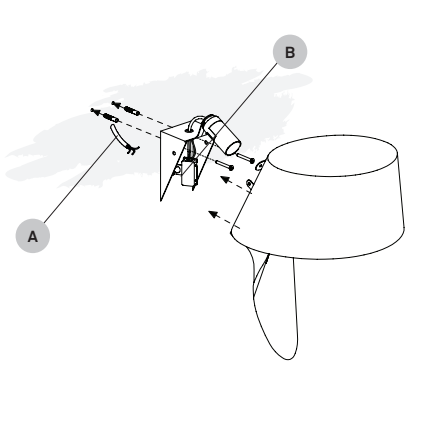

5 CONNECTION CONEXIÓN

You will have three wires coming from the wall. Connect the Neutral (N), Ground (GND) and Line (F) to the corresponding connectors on the mains terminal block marked in orange.

Tiene una manguera de tres polos que sale de la pared. Conecte el neutro (N), tierra (GND) y la línea (F) en la posición correspondiente a cada uno en la regleta de conexión naranja.

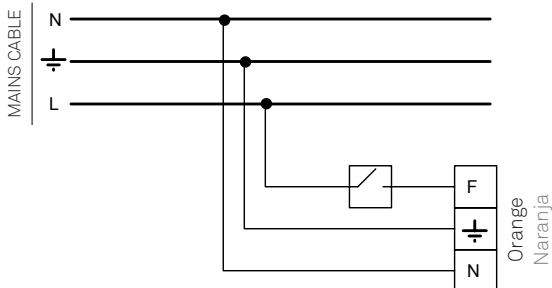

6 CLOSE CERRAR

Return the shade to its position. Put the holding screws back into place.

Colocar la pantalla en su posición una vez realizada la conexión y fijar los tornillos.

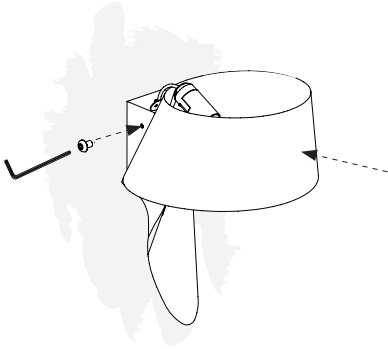

Use allen key N° 2,5
Usar llave allen N° 2,5

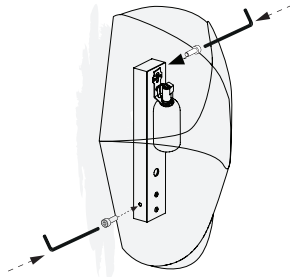

Use allen key N° 3
Usar llave allen N° 3

7 INSTALL THE BULB INSTALAR LA BOMBILLA

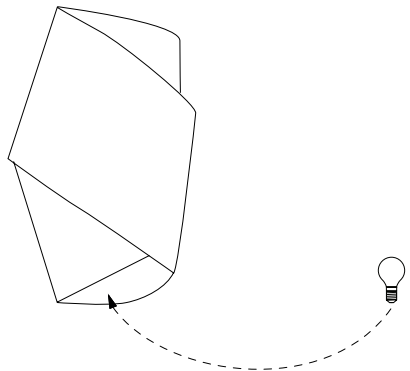
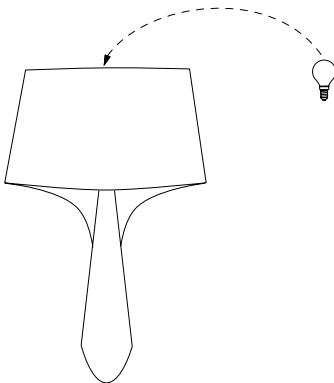

Use and care of your lamp.

You have just purchased an original handmade product by LZF. LZF is FSC® certified, dedicated to promoting responsible forest management worldwide. Our registered trademark license code is FSC® C110841. Your lamp is made from natural wood veneer from well-managed FSC® certified forests and other controlled sources, treated with our patented Timberlite® finish. This treatment both protects and safeguards the wood veneer against breakages...

CLEANING OF ...

The shades we recommend a feather duster or a damp cloth, clean only the flat surface of the veneer with the cloth, and please avoid any moisture contact along the edge of the veneer.

The metallic surfaces should be treated with care and cleaned with a soft damp cloth only. Make sure that moisture does not penetrate joins or junctions between metal parts. Use water. Do not use solvents or cleaning products any kind.

The acrylic diffusers on your lamp can be cleaned with a regular window cleaning spray and a soft cloth. Do not use solvents of any kind.

PRECAUTIONS**Luminaire for indoor use only.**

Unplug the lamp before cleaning. Servicing or manipulation of the electrical installation should only be performed by qualified electrical personnel or by the LZF service department.

Glass

Improper handling can cause loosening or chipping of the glass. Any bubbles, or lack of homogeneity in the glass is a characteristic feature of hand blown glass and not a defect. The surface of the glass may also include imperfections due to its manual manufacturing. When cleaning, use a window cleaning spray and a soft cloth. Avoid handling glass without gloves to prevent fingerprints and loss of gloss.

Wood veneer

Avoid direct sunlight, strong indirect sunlight and moisture on your lamp. Since wood is a natural material, a gradual change in tone may occur over time. Furthermore, if the lamps were purchased at different times, there will be differences in colour and tone, particularly in lighter coloured veneers. This is can not be considered a manufacturing defect or reason for complaint. Do not install your lamp near any air-conditioning vents or ventilation shafts as this may damage the wood veneer used in this fixture.

LEDS

If your lamps contains Integrated LED circuits do not touch the LED surface with your bare hands as this can reduce the life of your LED.

BULBS

Bulbs are normally not included, unless indicated. We recommend using energy-saving LED bulbs. Please refer to the instruction manual or visit our website www.lzf-lamps.com to make sure you are using the best bulb for your type of lamp.

KELVINS

Depending on the color of the wood veneer we recommend using different Kelvin light temperatures, for their optimum appearance: Blue 28, Turquoise 30 and Grey 29: 4000k
Ivory White 20, Natural Beech 22, and Natural Cherry 21: 3000 or 4000k.

Yellow 24, Orange 25, Red 26, Chocolate 31 & Pale Rose 33: 3000k.

Learn more about Kelvins.

Uso y cuidado de su lámpara

Acaba de adquirir un producto original y hecho a mano por LZF. LZF cuenta con la certificación FSC®, dedicada a promover el manejo forestal responsable en todo el mundo. Nuestro código de licencia de marca registrada es FSC® C110841. Su lámpara está fabricada con chapa de madera natural proveniente de bosques certificados FSC® bien manejados y de otras fuentes controladas, tratada con nuestro acabado patentado Timberlite®. Este tratamiento protege la madera, a la vez que evita posibles roturas.

LIMPIEZA DE ...

La madera, recomendamos usar un plumero o un paño húmedo, evitando incidir en los cantos de la chapa.

Las superficies metálicas deben tratarse con cuidado y limpiarse únicamente con un paño suave y húmedo. Asegúrese de que la humedad no penetre en las uniones de las partes metálicas. Use agua. No use disolventes ni productos de limpieza de ningún tipo.

Los difusores acrílicos se pueden limpiar con un líquido limpia cristales y un paño suave. No usar disolventes de ningún tipo.

PRECAUCIONES**Luminaria para uso exclusivo en interior.**

Desenchufar la lámpara antes de cambiar la bombilla o limpiarla. La manipulación de la instalación eléctrica debe efectuarse solo por personal cualificado o por LZF.

Vidrio

Un manejo inadecuado puede provocar que el vidrio se afloje o se astille. Cualquier burbuja, o falta de homogeneidad en el vidrio no es motivo de queja, este es un rasgo característico del vidrio soplado a mano.

La superficie del vidrio también puede presentar imperfecciones debido a su fabricación manual. Al limpiar, use un spray limpiacristales y un paño suave.

No manipule el vidrio sin guantes para evitar huellas dactilares y pérdida de brillo.

Madera

Evitar el sol directo o la luz intensa indirecta del sol y la humedad sobre la lámpara. Debido a que la madera es un material natural, pueden existir variaciones en el tono de ésta. Si las lámparas se adquieren en diferentes periodos de tiempo, pueden mostrar variaciones de color y tono sobre todo en las maderas de tonos claros. No situar la lámpara próxima a un salida de aire debido a que éste puede ocasionar daños en la misma. Luziferlamps S.L. no se hará responsable.

LEDS

Si su lámpara contiene LED integrado. No tocar nunca con las manos desnudas, ya que esto puede reducir la vida útil de su LED.

BOMBILLAS

Las bombillas no están incluidas, a menos que se indique. Recomendamos utilizar bombillas de bajo consumo LED. Consulte el manual de instrucciones o visite nuestro sitio web www.lzf-lamps.com para asegurarse de que está utilizando la mejor bombilla para su tipo de lámpara.

KELVINS

Dependiendo del color de la chapa de madera recomendamos utilizar diferentes temperaturas de luz, para su óptimo aspecto: Azul 28, Turquesa 30 y Gris 29: 4000k.

Ivory White 20, Natural Beech 22 y Natural Cherry 21: 3000 o 4000k. Amarillo 24, Naranja 25, Rojo 26, Chocolate 31 y Rosa Palo 33: 3000k.



© Luziferlamps, S.L. All rights reserved. Valencia, Spain. 2020 - www.lzf-lamps.com - support@lzf-lamps.com