

# NOVA LUCE

9853673

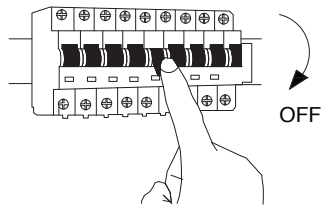

1. Turn off the general switch

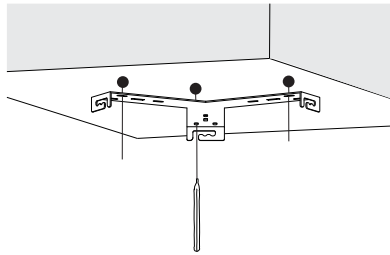

2. Mark where to drill holes

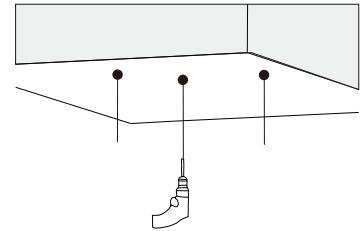

3. Drill on the marked areas

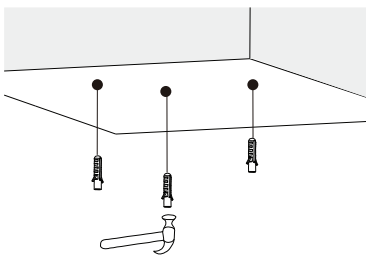

4. Apply plastic anchors

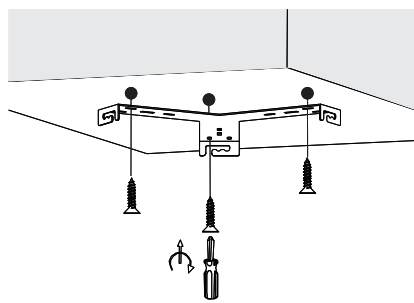

5. Apply screws

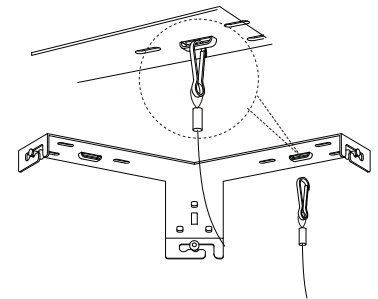

6. Make it stable

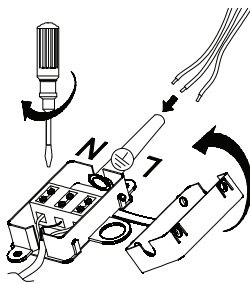

7. Connect the wires

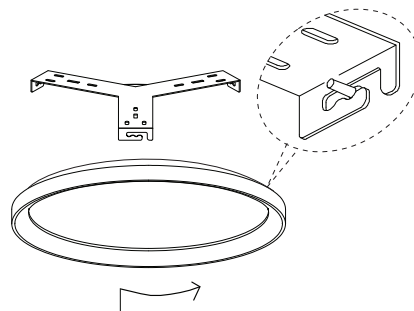

8. Adjust the wire & fix it into place

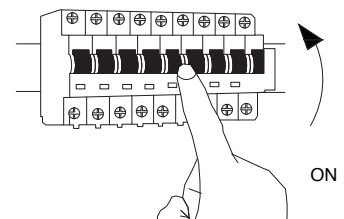

9. Turn on the general switch

