

Paul Neuhaus

Paul Neuhaus GmbH  
Olakenweg 36 · 59457 Werl  
Germany

Telefon: +49 (0) 29 22-97 21-0  
Telefax: +49 (0) 29 22-97 21-9120  
E-mail: info@neuhaus-group.de  
<https://scm.paul-neuhaus.de/public/conformity/>

 SMART  
HOME  
LIGHTS

D | Montageanleitung • GB | Fitting instructions







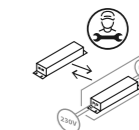
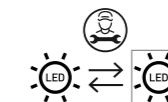

- DE** Dieses Produkt enthält Lichtquellen der Energieeffizienzklasse <E>.
- GB** This product contains light sources of energy efficiency class <E>.
- FR** Ce produit comprend sources lumineuses de classe d'efficience énergétique <E>.
- BG** Продуктът съдържа източници на светлина с клас на енергийна ефективност <E>.
- CZ** Tento výrobek obsahuje světelné zdroje třídy energetické účinnosti <E>.
- DK** Dette produkt indeholder lyskilder af energieeffektklasse <E>.
- EL** Αυτό το προϊόν περιέχει πηγές φωτός της τάξης ενεργειακής απόδοσης <E>.
- ES** Este producto contiene fuentes de luz de la clase de eficiencia energética <E>.
- ET** See toode sisaldab valgusallikad energiatõhusklassiga <E>.
- FI** Tämä tuote sisältää energiatehokkuusluokan <E> valonlähteet.
- HR** Ovak proizvod sadrži izvori svjetlosti energetskog razreda <E>.
- HU** Ez a termék <E> energiahatákonysági osztályba tartozó fényforrások tartalmaz.
- IT** Questo prodotto contiene sorgenti luminose della classe di efficienza energetica <E>.
- LT** Šis produktas yra su šviesos šaltiniai, kurio energinio efektyvumo klasė yra <E>.
- LV** Šis izstrādājums satur gaismas avoti, kas atbilst energoefektivitātes klasei <E>.
- NL** Dit product bevat lichtbronnen van energie-efficiëntieklasse <E>.
- NO** Dette produktet inneholder lyskilder i energieffektivitetsklasse <E>.
- PL** Produkt ten zawiera źródła światła o klasie efektywności energetycznej <E>.
- PT** Este produto contém fontes de luz da classe de eficiência energética <E>.
- RO** Acest produs conține surse de lumină din clasa de eficiență energetică <E>.
- RU** Данное изделие содержит источники света класса энергоэффективности <E>.
- SK** Tento výrobok obsahuje svetelné zdroje triedy energetickej efektivity <E>.
- SL** Ta izdelek vsebuje viri svetlobe razreda energijske učinkovitosti <E>.
- SR** Ovak proizvod sadrži izvori svjetlosti energetske klase <E>.
- SV** Denna produkt innehåller ljuskällor i energieffektivitetsklass <E>.
- TR** Bu ürün, enerji verimliliği sınıfına sahip ışık kaynakları içerir <E>.

**835924**

230V/50   
1x LED-Board 24V DC / 7W  
1x LED-Board 24V DC / 20W  
nicht wechselbar / not changeable

 2,4 GHz  
10 dBm



	7 W / 20 W
	850 lm / 2.500 lm
	32 W
	1.600 lm
	LED-Board
<b>t</b>	25.000 h
<b>Tk</b>	2.700 - 5.000 K
	15.000 x
	< 0,5 s
	dimmable with rrc



Inkl. Funkfernbedienung  
Incl. radio remote control



## 1 | Montage / fitting

als Deckenleuchte  
as ceiling light

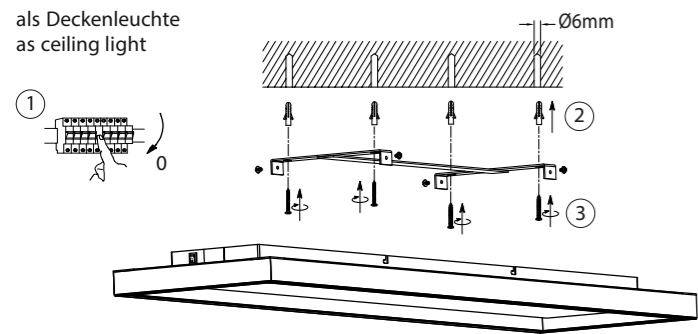

## 2 | Elektrischer Anschluss / electrical connection

230 Volt/50 Hz-Anschluss  
230 voltage/50 Hz connection

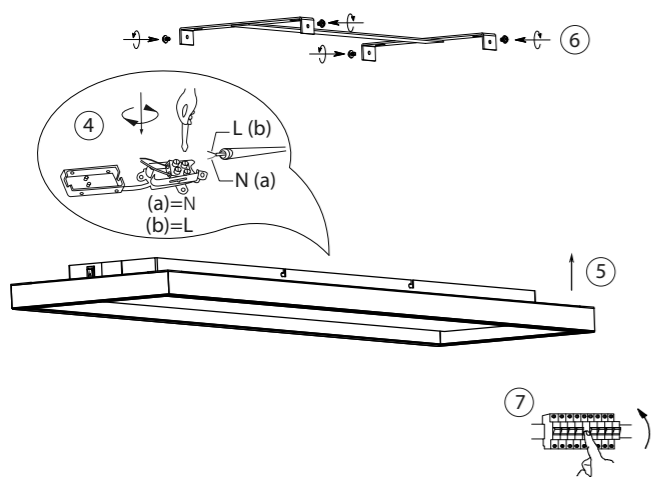

## 3 | Fernbedienung anlernen / teach remote control

Siehe Q-Fernbedienungsanleitung  
See Q-remote control manual

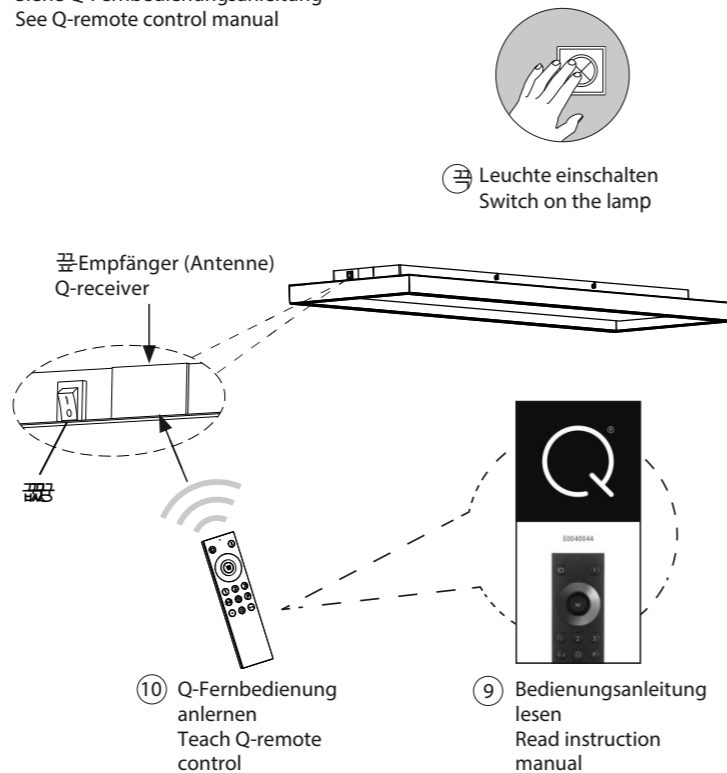

## ! Reset

공기청정기 리모컨을 사용하여 리셋을 수행합니다.  
Use the air purifier remote control to perform the reset.  
공기청정기 리모컨을 사용하여 리셋을 수행합니다.  
Use the air purifier remote control to perform the reset.

5 x on/off

