

D

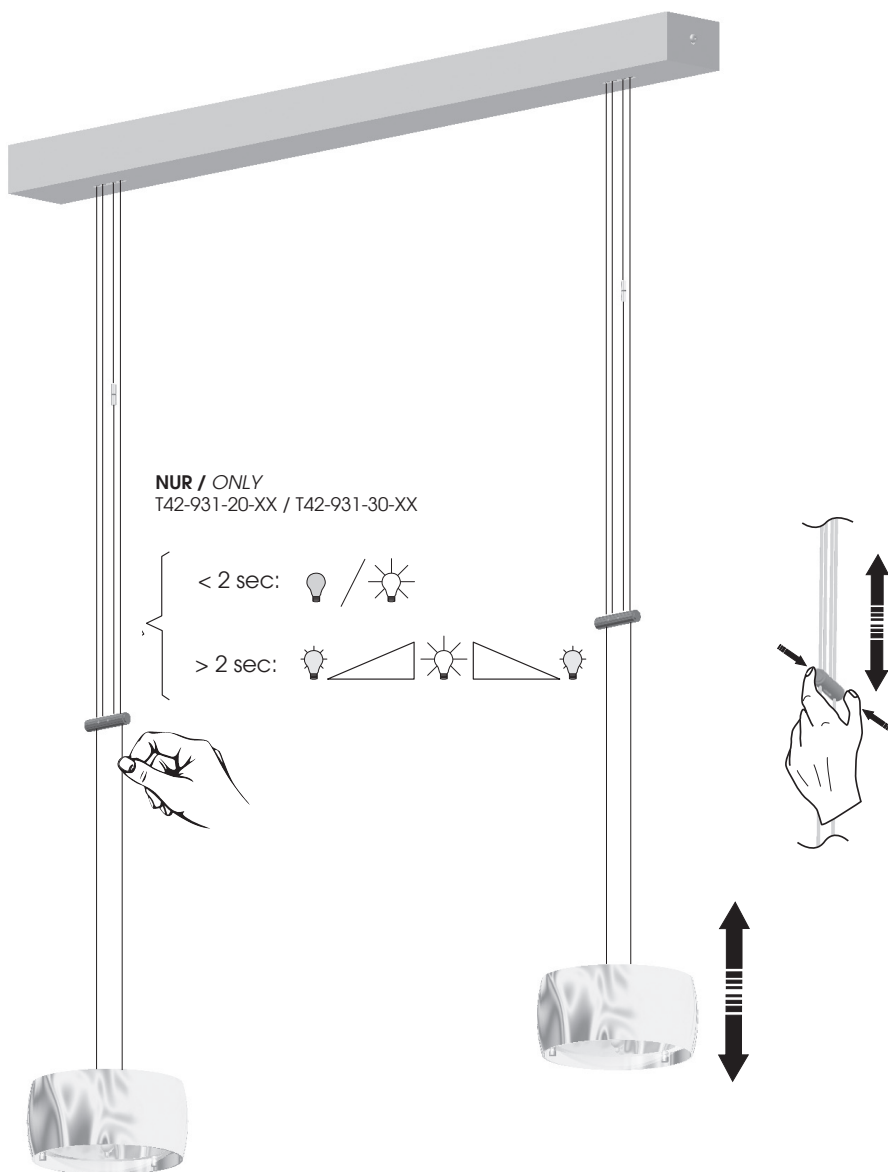

NUR / ONLY
T42-931-20-XX / T42-931-30-XX

< 2 sec:  / 

> 2 sec:     

GRACE

PENDANT

Design: Ralf Keferstein

OLIGO Lichttechnik GmbH
Tannenweg 1
DE - 53757 Sankt Augustin
Germany
www.oligo.de
info@oligo.de

Art.-Nr. / Item-No.







42-931-20-XX

42-931-30-XX

T42-931-20-XX

T42-931-30-XX

	~230-240V/12V 50-60 Hz	max. 2x/3x 50W	2x/3x GY6,35	2x/3x QT-LP 12
(D)	Spannung	Belastung	Fassung	Lampe
(GB)	Voltage	Loading	Fitting	Bulb
(NL)	Spanning	Belasting	Fitting	Verlichtingsmiddel
(F)	Tension	Charge	Douille	Ampoule
(I)	Tensione	Carico	Portalampada	Sorgente luminosa
(ES)	Tensión	Carga	Portalamparas	Lámpara
(P)	Tensão	Carga	Casquilho	Lâmpada
(DK)	Spænding	Belastning	Fatning	Pære
(S)	Spänning	Belastning	Fattning	Ljuskälla
(N)	Spenning	Fatning	Belastning	Lampe
(FI)	Jännite	Kuormitus	Kanta	Lamppu
(TR)	Gerilim	Yük	Duy	Lamba
(PL)	Napięcie	Oprawka	Obciążenie	Lampa
(GR)	Τάση	Υποδοχή	Φορτίο	Λαμπτήρας
(RUS)	Напряжение	Нагрузка	Патрон	Лампочка
(UAB)	الجهد الكهربی	الدوأة	الحمل	المصباح

A  
SAFETY INSTRUCTIONS

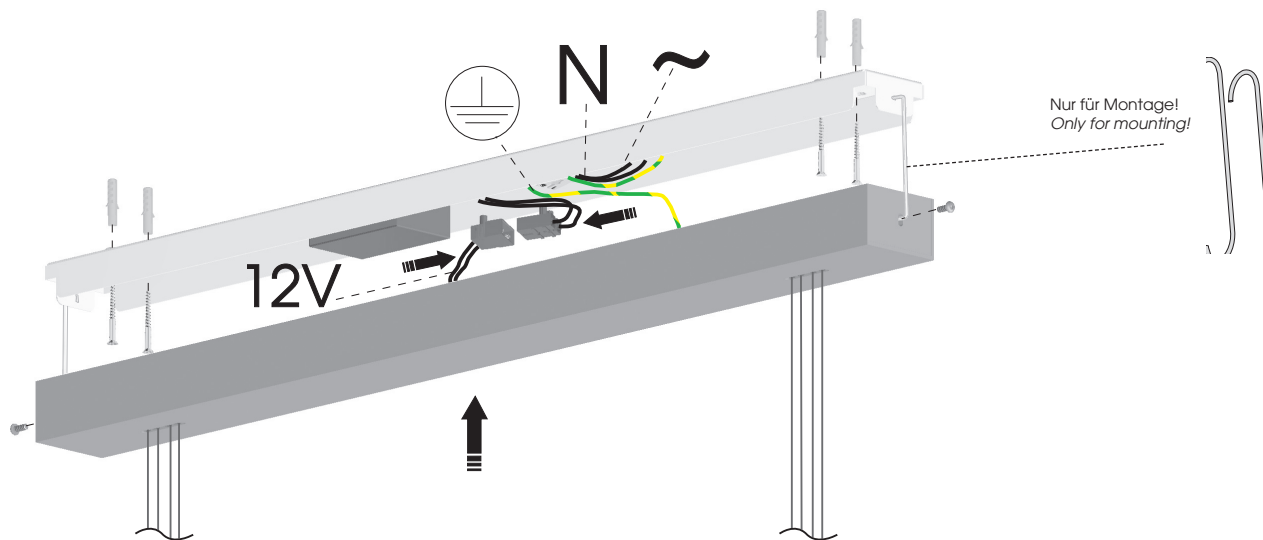

B

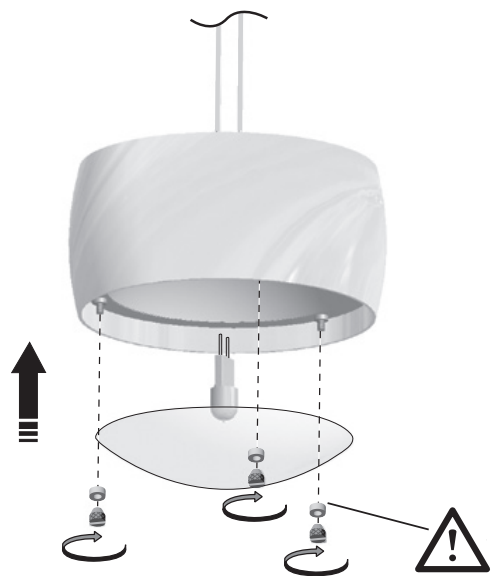

C

