

Paul Neuhaus

Paul Neuhaus GmbH
Olakenweg 36 · 59457 Werl
Germany

Telefon: +49 (0) 29 22-97 21-0
Telefax: +49 (0) 29 22-97 21-9120
E-mail: info@neuhaus-group.de
<https://scm.paul-neuhaus.de/public/conformity/>



D | Montageanleitung • GB | Fitting instructions

- DE** Dieses Produkt enthält Lichtquellen der Energieeffizienzklasse <E>.
- GB** This product contains light sources of energy efficiency class <E>.
- FR** Ce produit comprend sources lumineuses de classe d'efficacité énergétique <E>.
- BG** Продуктът съдържа източници на светлина с клас на енергийна ефективност <E>.
- CZ** Tento výrobek obsahuje světelné zdroje třídy energetické účinnosti <E>.
- DK** Dette produkt indeholder lyskilder af energieeffektklasse <E>.
- EL** Αυτό το προϊόν περιέχει πηγές φωτός της τάξης ενεργειακής απόδοσης <E>.
- ES** Este producto contiene fuentes de luz de la clase de eficiencia energética <E>.
- ET** See toode sisaldab valgusallikad energiatõhusklassiga <E>.
- FI** Tämä tuote sisältää energiatehokkuusluokan <E> valonlähteet.
- HR** Ovaj proizvod sadrži izvori svjetlosti energetskog razreda <E>.
- HU** Ez a termék <E> energiahatékonysági osztályba tartozó fényforrások tartalmaz.
- IT** Questo prodotto contiene sorgenti luminose della classe di efficienza energetica <E>.
- LT** Šis produktas yra su šviesos šaltiniai, kurio energinio efektyvumo klasė yra <E>.
- LV** Šis izstrādājums satur gaismas avoti, kas atbilst energoefektivitātes klasei <E>.
- NL** Dit product bevat lichtbronnen van energie-efficiëntieklasse <E>.
- NO** Dette produktet inneholder lyskilder i energieffektivitetsklasse <E>.
- PL** Produkt ten zawiera źródła światła o klasie efektywności energetycznej <E>.
- PT** Este produto contém fontes de luz da classe de eficiência energética <E>.
- RO** Acest produs conține surse de lumină din clasa de eficiență energetică <E>.
- RU** Данное изделие содержит источники света класса энергоэффективности <E>.
- SK** Tento výrobok obsahuje svetelné zdroje triedy energetickej efektivity <E>.
- SL** Ta izdelek vsebuje viri svetlobe razreda energijske učinkovitosti <E>.
- SR** Ovaj proizvod sadrži izvori svjetlosti energetske klase <E>.
- SV** Denna produkt innehåller ljuskällor i energieffektivitetsklass <E>.
- TR** Bu ürün, enerji verimliliği sınıfına sahip ışık kaynakları içerir <E>.

835809

230V/50Hz~
7x LED-Board 54V DC / 7x 1W
nicht wechselbar / not changeable

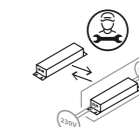
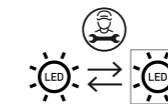

	7,5 W
	1.000 lm
	60 W
	4.000 lm
	LED-Board
t	25.000 h
Tk	2.700 - 5.000 K
	15.000 x
	

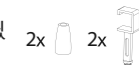
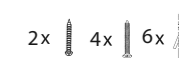
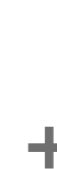
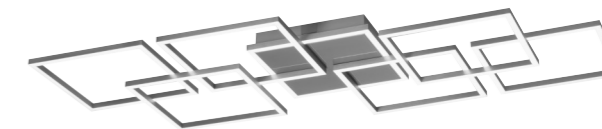

Inkl. IR-Fernbedienung
Incl. IR remote control



1 | Montage / fitting

als Deckenleuchte
as ceiling light

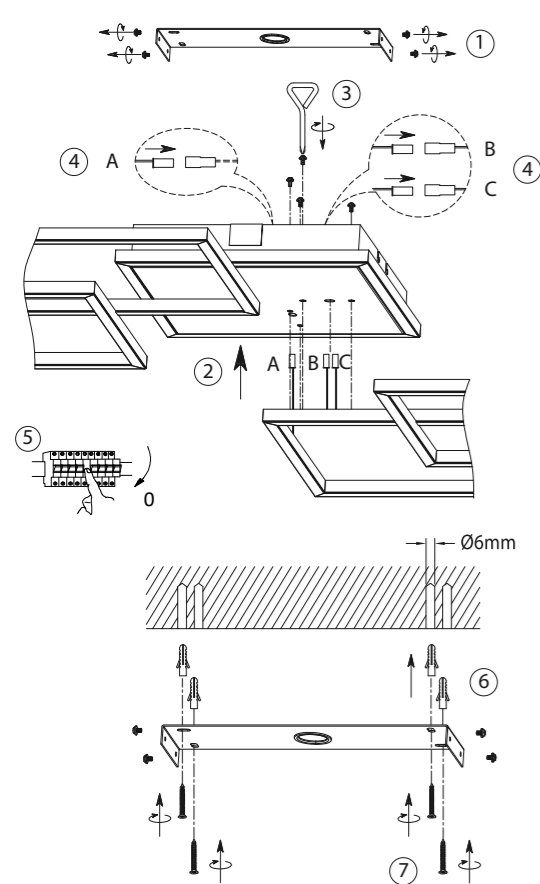

2 | Elektrischer Anschluss / electrical connection

230 Volt/50 Hz-Anschluss
230 voltage/50 Hz connection

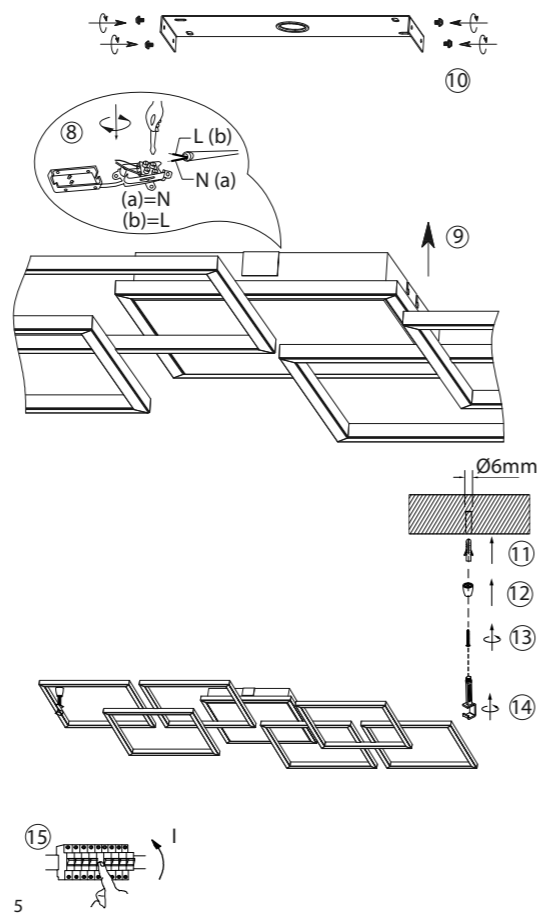

3 | Fernbedienung anlernen / teach remote control

Siehe Q-Fernbedienungsanleitung
See Q-remote control manual

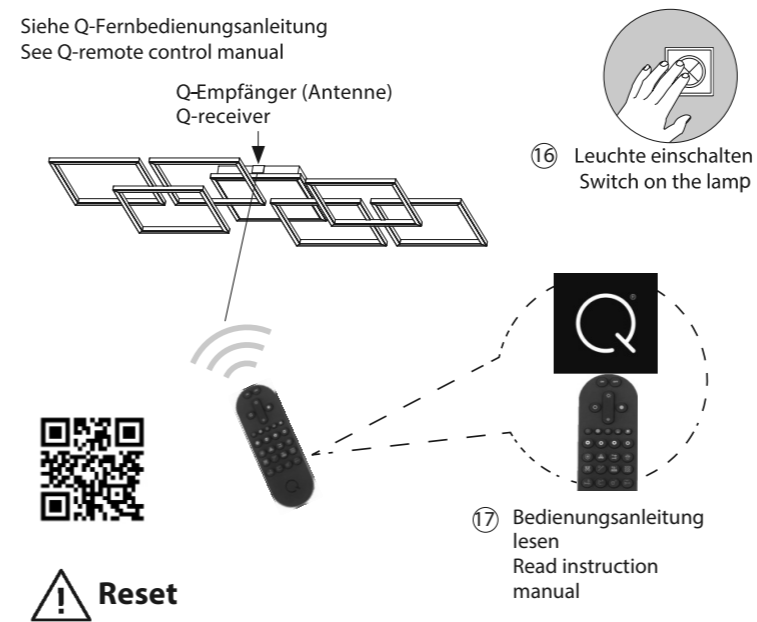

Reset

Zur Einbindung in ein ZigBee Netzwerk, stellen Sie die Leuchte auf Werkseinstellung zurück.

To integrate the lamp into a ZigBee network, reset the lamp to the factory setting.

5 x on/off

