



SMART  
HOME  
LIGHTS

D | Montageanleitung • GB | Fitting instructions

# 832275

230V / 50Hz~

1x LED-Board 36V DC / 39W

nicht wechselbar / not changeable

 2,4GHz  
8,5dBm



39W  
4.900 lm



45W  
3.600 lm



LED-Board

t

25.000 h

Tk

2.700K-5.000K / RGB



15.000 x



< 0,5 s



dimmable with rrc

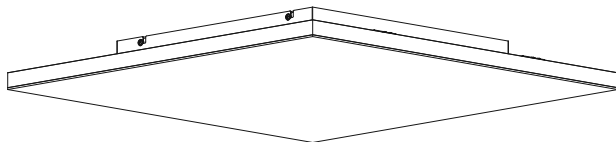

4x 

4x 



AAA, 1,5V

Inkl. Funkfernbedienung  
Incl. radio remote control



# 1 | Montage/fitting

Als Deckenleuchte  
As ceiling lamp

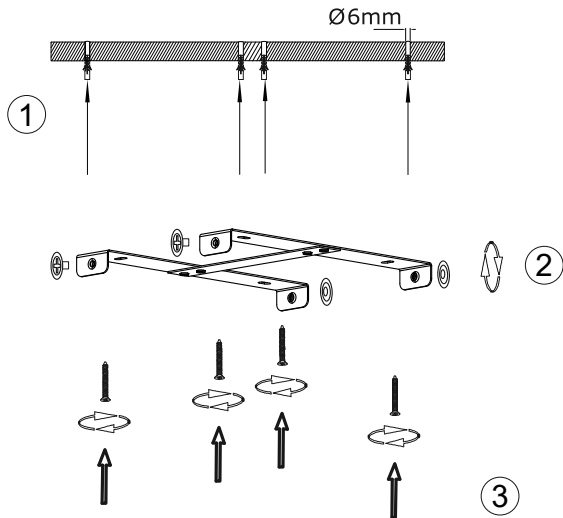

## 2 | Elektrischer Anschluss/electrical connection

230 Volt/50 Hz-Anschluss

230 Voltage/50 Hz connection



5

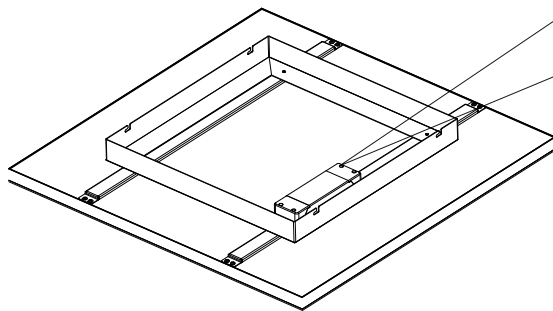
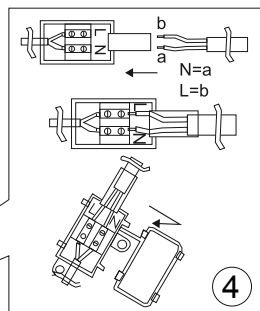

### 3 | Fernbedienung anlernen/teach remote control

Siehe Q-Fernbedienungsanleitung

See Q-remote control manual

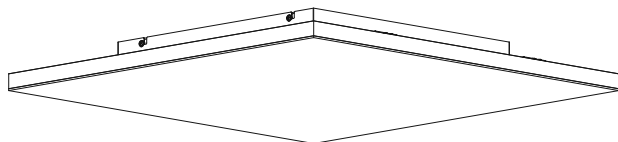

5



Leuchte einschalten  
Switch on the lamp



7

Q-Fernbedienung  
anlernen  
Teach Q-remote  
control

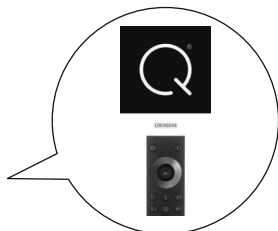

6

Bedienungsanleitung  
lesen  
Read instruction  
manual





Rückstellen der Leuchte auf Werkseinstellung  
Reset the lamp, factory new

5 x on/off

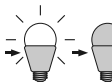

5-10 sec.



1-2 sec.

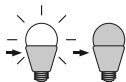

1-2 sec.

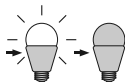

1-2 sec.

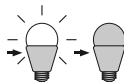

1-2 sec.



Das Gerät erfüllt die grundlegenden Anforderungen der Richtlinie 2014/53/EU (Radio Equipment Directive) des Europäischen Parlaments und des Rates der europäischen Union vom 16.04.2014 über Funkanlagen. Die vollständige Konformitätserklärung kann bei der unten stehenden Internet-Adresse aufgerufen werden.

This device fulfils the fundamental requirements of Directive 2014/53/EU (Radio Equipment Directive) of the European Parliament and of the Council of the European Union dated 16.04.2014 on items of radio equipment. The full declaration of conformity can be accessed at the Internet-address given below.

*Paul Neuhaus*

Paul Neuhaus GmbH  
Olakenweg 36 · 59457 Werl  
Germany

Telefon: +49(0)2922-9721-0  
Telefax: +49(0)2922-9721-9120  
E-mail: kundenservice@neuhaus-group.de  
<https://scm.paul-neuhaus.de/public/conformity/>