

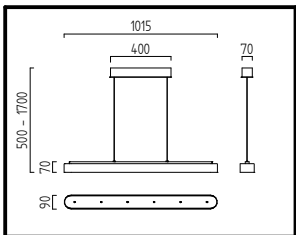

**BORA**   
16/1704.xx

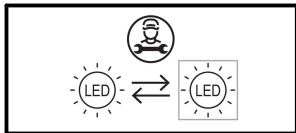
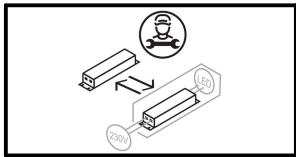
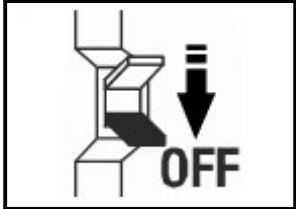
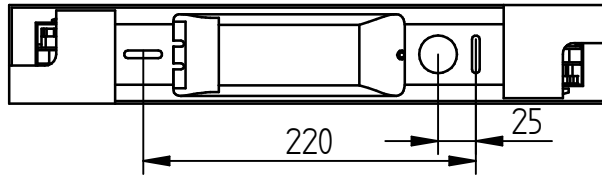

**Achtung!**  
Easylift ist  
**werkseitig eingestellt!**  
Rückzugfeder kann bei  
Bedarf eingestellt werden.

**Transportsicherung**  
bitte entfernen

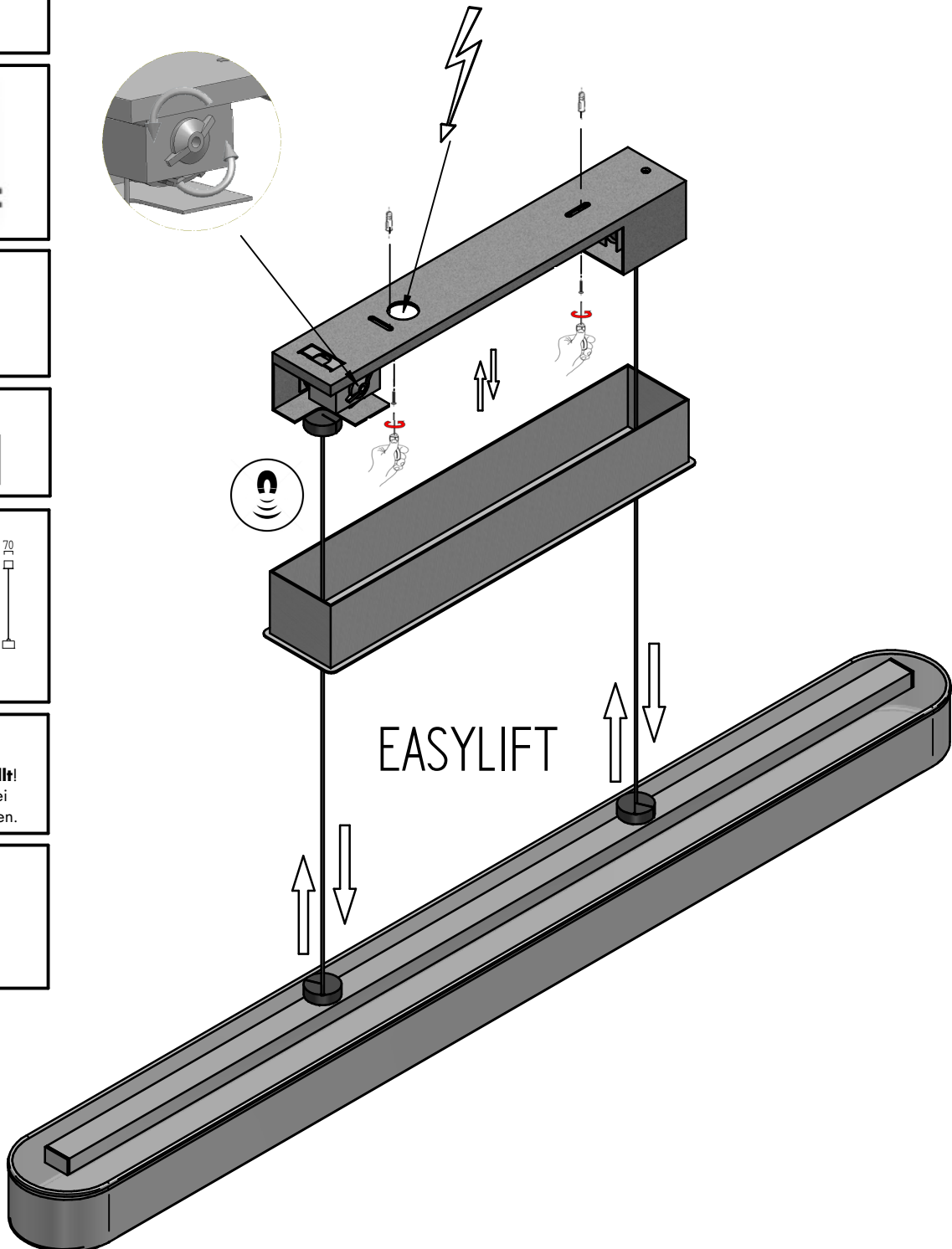
Bitte beachten Sie unsere allgemeinen Hinweise !  
Please observe our general information !  
Nous vous prions d'observer nos instructions générales !  
Observen por favor nuestra información general !



[www.helestra.de/installation](http://www.helestra.de/installation)

**Helestra Leuchten GmbH**  
An den Breiten 7, 01454 Leppersdorf, Deutschland/Germany

[www.helestra.de](http://www.helestra.de)